

Parameter	Value	Unit
$V_{DS}$	60	V
$R_{DS(ON) max. V_{GS}=10V}$	9.8	mΩ
$R_{DS(ON) max. V_{GS}=4.5V}$	15.4	mΩ
$I_D$	44.8	A
$Q_{g 10V}$	15.6	nC
$Q_{gd}$	3.5	nC
$Q_{SW}$	5.5	nC

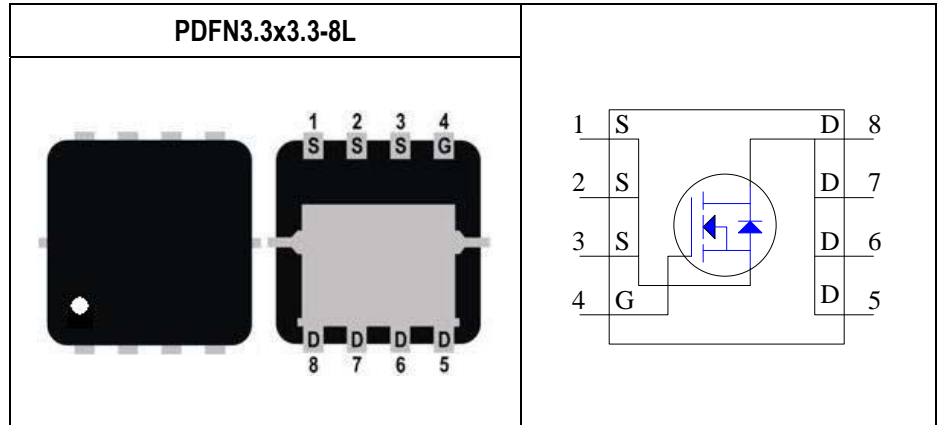

Features	Application
<ul style="list-style-type: none"> <li>Low On-Resistance <math>R_{DS(on)}</math></li> <li>Low Input Capacitance</li> <li>Low Gate Charge</li> <li>Fully Characterized Capacitance and Avalanche</li> <li>Pb-free lead plating; RoHS compliant</li> </ul>	<ul style="list-style-type: none"> <li>AC to DC adaptor</li> <li>DC to DC Converter</li> <li>Switch Mode Power Supply</li> <li>Lithium-Ion Secondary Batteries</li> <li>MOSFET for synchronous rectification in SMPS</li> </ul>

## Ordering Information

Ordering Code	RoHS Status	Package	Package Code	Packing	Quantity
DG60N12E	Halogen-Free	PDFN3.3x3.3-8L	E	Tape & Reel	5,000

## Absolute Maximum Ratings ( $T_J=25^\circ\text{C}$ unless otherwise noted)

Parameter	Symbol	Value	Unit	
Drain-Source Voltage	$V_{DS}$	60	V	
Gate-Source Voltage	$V_{GS}$	$\pm 20$	V	
Drain Current-Continuous <sup>Note 1</sup>	$I_D$	$T_C=25^\circ\text{C}$	44.8	A
		$T_C=100^\circ\text{C}$	28.3	A
Drain Current-Continuous <sup>Note 2</sup>	$I_D$	$T_A=25^\circ\text{C}$	10	A
		$T_A=70^\circ\text{C}$	8	A
Drain Current-Pulsed <sup>Note 3</sup>	$I_{DM}$	55	A	
Avalanche Current	$I_{AR}$	16.3	A	
Single Pulse Avalanche Energy <sup>Note 4</sup>	$E_{AS}$	13.3	mJ	
Maximum Power Dissipation	$P_D$	$T_C=25^\circ\text{C}$	30.1	W
		$T_C=100^\circ\text{C}$	12	W
		$T_A=25^\circ\text{C}$	1.51	W
		$T_A=70^\circ\text{C}$	0.97	W
Operating and Storage Temperature Range	$T_J, T_{STG}$	-55 to 150	$^\circ\text{C}$	

## Thermal Resistance Ratings

Parameter	Symbol	Conditions	Min.	Typ.	Max.	Unit
Thermal resistance, Junction-Case <sup>Note 5</sup>	$R_{\theta JC}$	Steady State	-	-	4.15	$^\circ\text{C/W}$
Thermal resistance, Junction-Ambient <sup>Note 5</sup>	$R_{\theta JA}$	Steady State	-	-	82.46	$^\circ\text{C/W}$

### Notes:

- Limited by silicon chip capability and  $R_{\theta JC}$  junction-to-case thermal resistance.
- The maximum current rating is limited by package and  $R_{\theta JA}$  junction-to-ambient thermal resistance.
- Must be ensure junction temperature does not exceed 150-degree C. (Pulse Width  $\leq 100\mu\text{s}$ , Duty  $\leq 2\%$ )
- Limited by  $T_{Jmax}$ , starting  $T_J=25^\circ\text{C}$ ,  $L=0.1\text{mH}$ ,  $R_g=25\Omega$ ,  $I_D=16.3\text{A}$ ,  $V_{GS}=10\text{V}$ .
- The value of thermal resistance is measured with the single device mounted on 1 inch<sup>2</sup> FR-4 PCB with 2 oz. copper under a still air environment temperature is 25 $^\circ\text{C}$  based on JEDEC standard JESD51-14 and JESD51-2a. Thermal resistance obtained depends on the user's specific board design and given application.

**Electrical Characteristics (T<sub>J</sub>=25°C unless otherwise noted)**

STATIC CHARACTERISTICS						
Parameter	Symbol	Conditions	Min.	Typ.	Max.	Unit
Drain-Source Breakdown Voltage	$V_{(BR)DSS}$	$V_{GS}=0V, I_{DS}=250\mu A$	60	-	-	V
Zero Gate Voltage Drain Current	$I_{DSS}$	$V_{DS}=60V, V_{GS}=0V$	-	-	1	$\mu A$
		$V_{DS}=60V, V_{GS}=0V, T_J=105^\circ C$	-	-	100	$\mu A$
Gate-Body Leakage	$I_{GSS}$	$V_{GS}=\pm 20V, V_{DS}=0V$	-	-	$\pm 100$	nA

STATIC CHARACTERISTICS						
Parameter	Symbol	Conditions	Min.	Typ.	Max.	Unit
Gate Threshold Voltage	$V_{GS(TH)}$	$V_{DS}=V_{GS}, I_{DS}=250\mu A$	1.3	1.7	2.1	V
Drain-Source On-State Resistance	$R_{DS(ON)}$	$V_{GS}=10V, I_{DS}=20A$	-	8.5	9.8	m $\Omega$
		$V_{GS}=4.5V, I_{DS}=10A$	-	13.4	15.4	m $\Omega$
Gate Resistance	$R_g$	$V_{GS}=0V, V_{DS}=0V, f=1MHz$	-	1.5	-	$\Omega$
Forward Transconductance	$g_{fs}$	$V_{DS}=5V, I_{DS}=11A$	-	10	-	S

DYNAMIC CHARACTERISTICS						
Parameter	Symbol	Conditions	Min.	Typ.	Max.	Unit
Input Capacitance	$C_{iss}$	$V_{DD}=60V, V_{DS}=30V, V_{GS}=0V, f=1MHz$	-	834	-	pF
Output Capacitance	$C_{oss}$	$V_{DD}=60V, V_{DS}=30V, V_{GS}=0V, f=1MHz$	-	364	-	pF
Reverse Transfer Capacitance	$C_{rss}$	$V_{DD}=60V, V_{DS}=30V, V_{GS}=0V, f=1MHz$	-	31	-	pF
Turn-On Delay Time	$T_{d(on)}$	$V_{DS}=30V, V_{GS}=10V, I_{DS}=14A, R_{GEN}=3\Omega$	-	7.9	-	nS
Rise Time	$t_r$	$V_{DS}=30V, V_{GS}=10V, I_{DS}=14A, R_{GEN}=3\Omega$	-	2	-	nS
Turn-Off Delay Time	$T_{d(off)}$	$V_{DS}=30V, V_{GS}=10V, I_{DS}=14A, R_{GEN}=3\Omega$	-	19.7	-	nS
Fall Time	$t_f$	$V_{DS}=30V, V_{GS}=10V, I_{DS}=14A, R_{GEN}=3\Omega$	-	5.2	-	nS

GATE CHARGE CHARACTERISTICS						
Parameter	Symbol	Conditions	Min.	Typ.	Max.	Unit
Gate to Source Gate Charge	$Q_{gs}$	$V_{DD}=30V, I_D=20A, V_{GS}=0$ to 10V	-	3.7	-	nC
Gate charge at threshold	$Q_{g(th)}$	$V_{DD}=30V, I_D=20A, V_{GS}=0$ to 10V	-	1.6	-	nC
Gate to Drain Charge	$Q_{gd}$	$V_{DD}=30V, I_D=20A, V_{GS}=0$ to 10V	-	3.5	-	nC
Switching charge	$Q_{SW}$	$V_{DD}=30V, I_D=20A, V_{GS}=0$ to 10V	-	5.5	-	nC
Gate charge total	$Q_{g 10V}$	$V_{DD}=30V, I_D=20A, V_{GS}=0$ to 10V	-	15.6	-	nC
	$Q_{g 4.5V}$	$V_{DD}=30V, I_D=20A, V_{GS}=0$ to 4.5V	-	7.6	-	nC
Gate plateau voltage	$V_{plateau}$	$V_{DD}=30V, I_D=20A, V_{GS}=0$ to 10V	-	3.9	-	V
Gate charge total, sync. FET ( $Q_g - Q_{gd}$ )	$Q_{g(sync)}$	$V_{DS}=0.1V, V_{GS}=0$ to 10V	-	12.1	-	nC

DRAIN-SOURCE DIODE CHARACTERISTICS AND MAXIMUM RATINGS						
Parameter	Symbol	Conditions	Min.	Typ.	Max.	Unit
Body Diode continuous forward current	$I_S$	$T_C=25^\circ C$	-	-	44.8	A
Body Diode pulse current	$I_{SM}$	$T_C=25^\circ C$	-	-	55	A
Body Diode Forward Voltage	$V_{SD}$	$V_{GS}=0V, I_S=1A$	-	0.7	1.0	V
Body Diode Reverse Recovery Time	$t_{rr}$	$V_{DD}=30V, I_F=11A, di/dt=100A/\mu s$	-	28.4	-	nS
		$V_{DD}=30V, I_F=11A, di/dt=200A/\mu s$	-	24	-	nS
Body Diode Reverse Recovery Charge	$Q_{rr}$	$V_{DD}=30V, I_F=11A, di/dt=100A/\mu s$	-	15	-	nC
		$V_{DD}=30V, I_F=11A, di/dt=200A/\mu s$	-	26.1	-	nC

Typical Operating Characteristics

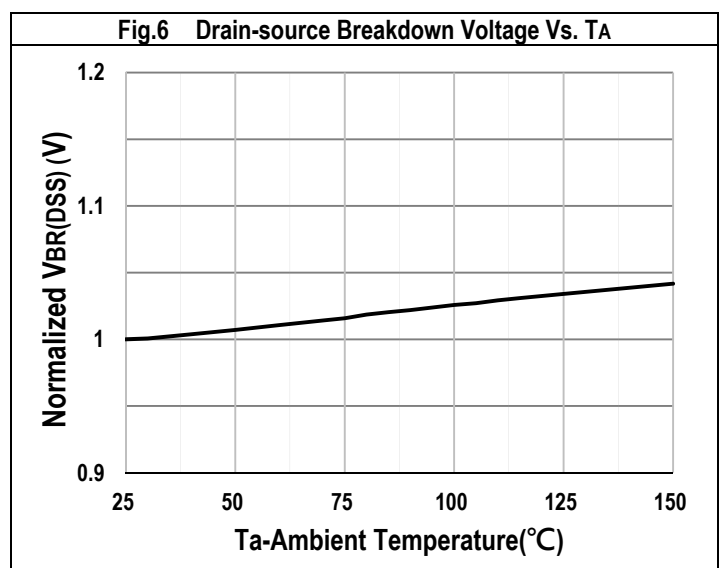
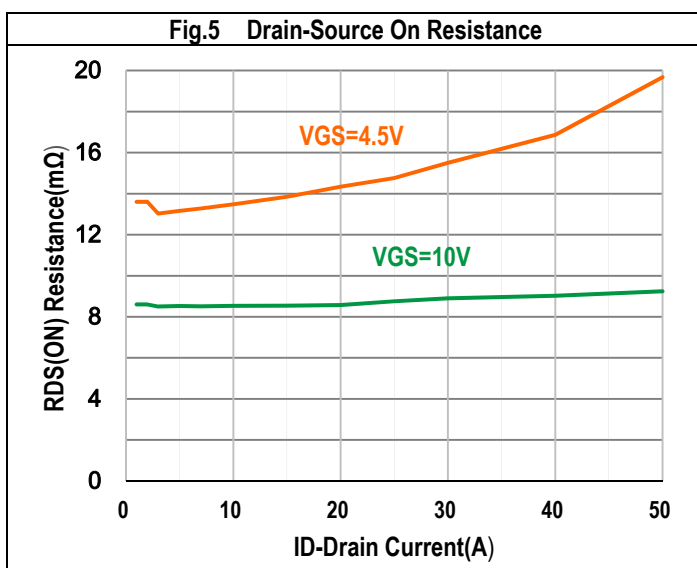
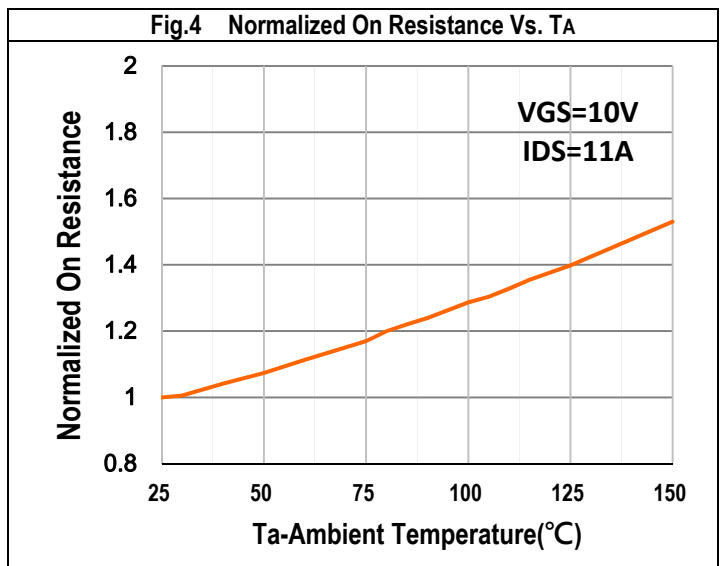
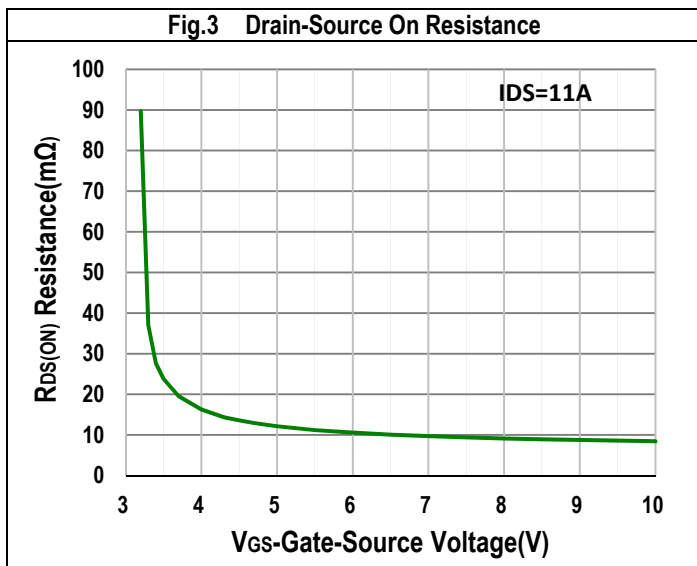
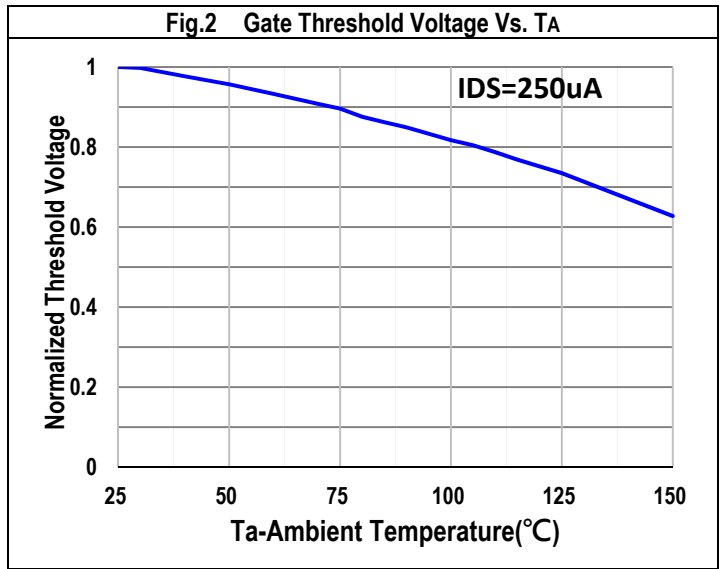
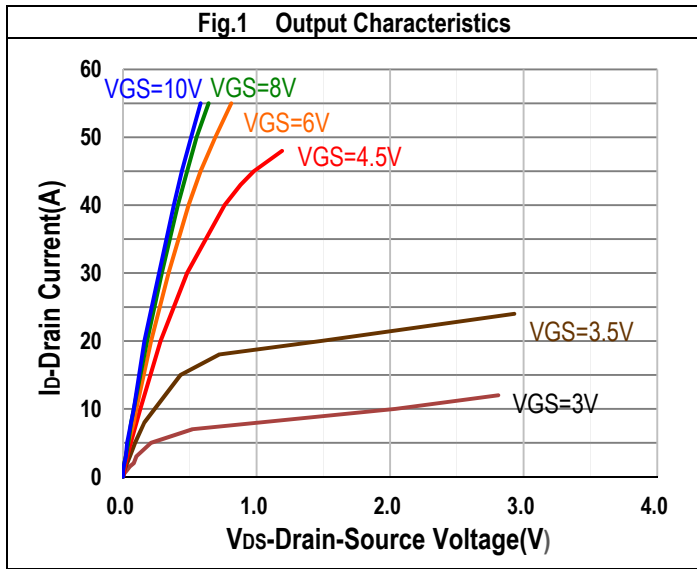

Typical Operating Characteristics (Cont.)

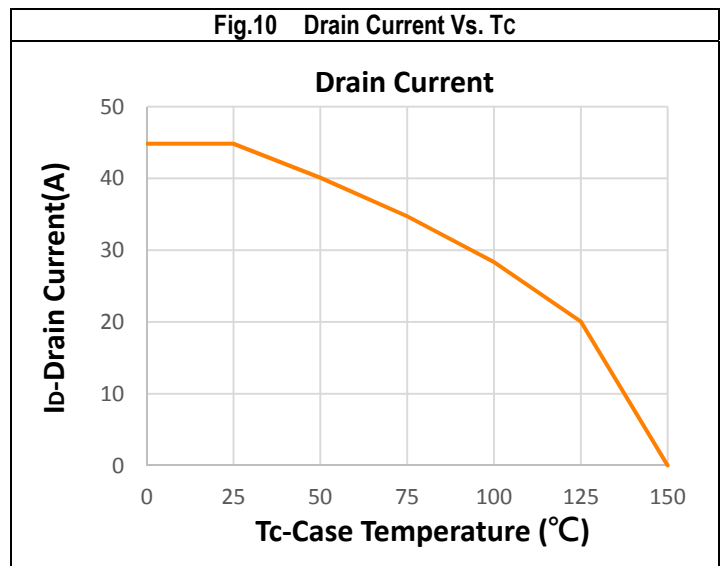
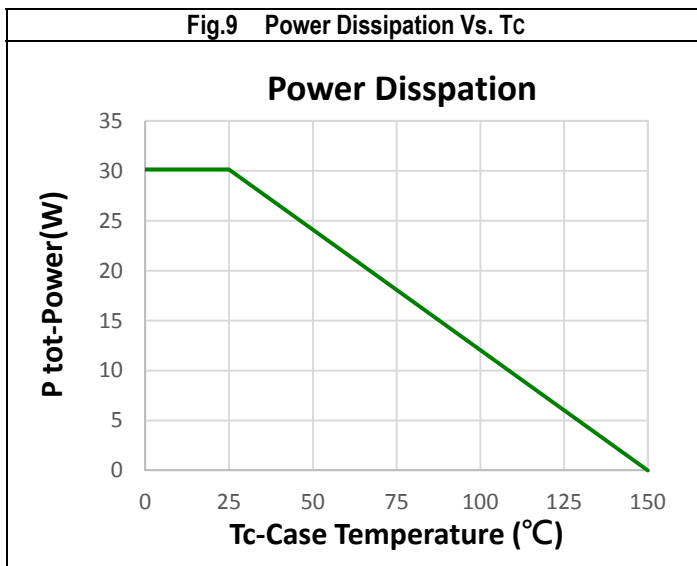
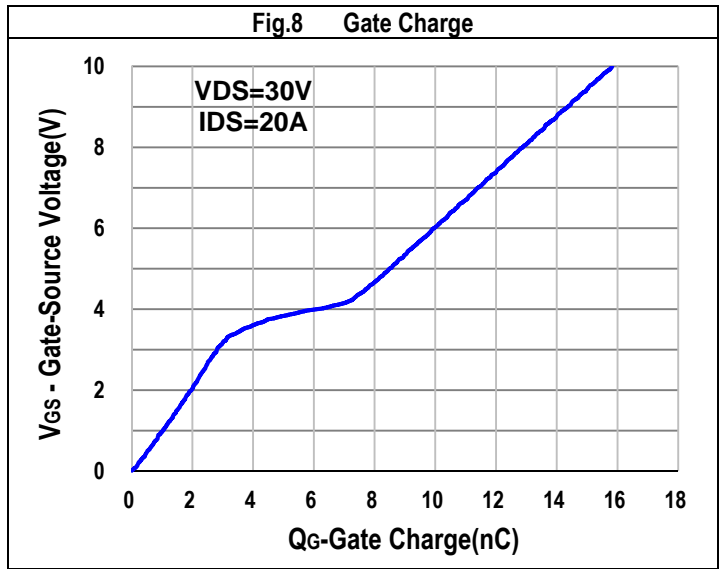
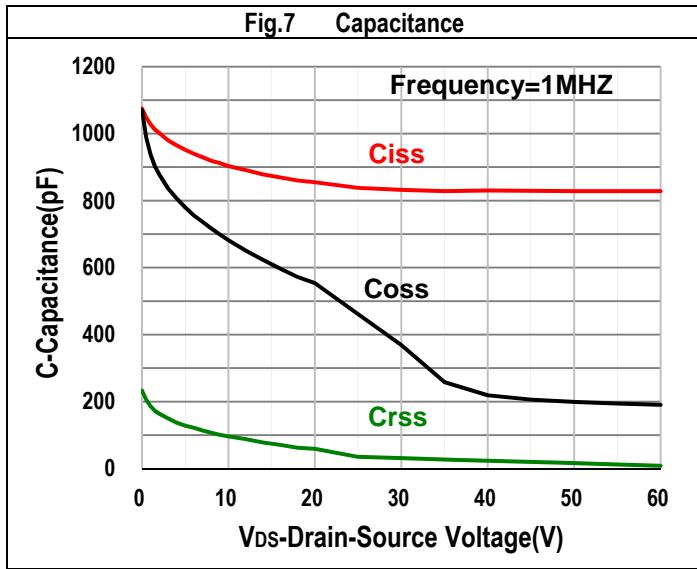

**Fig.11 Safe Operation Area**

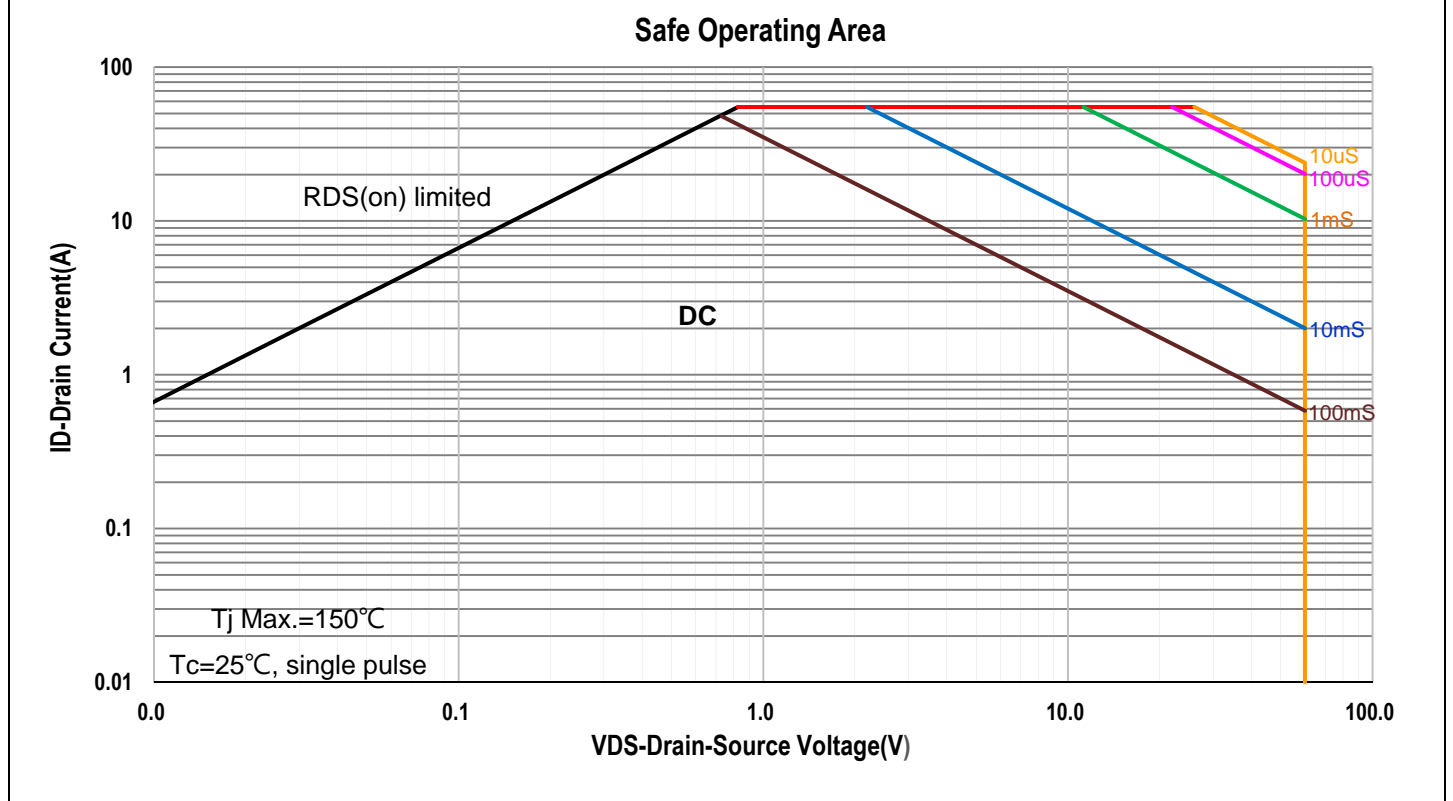

**Fig.12 Transient Thermal Impedance**

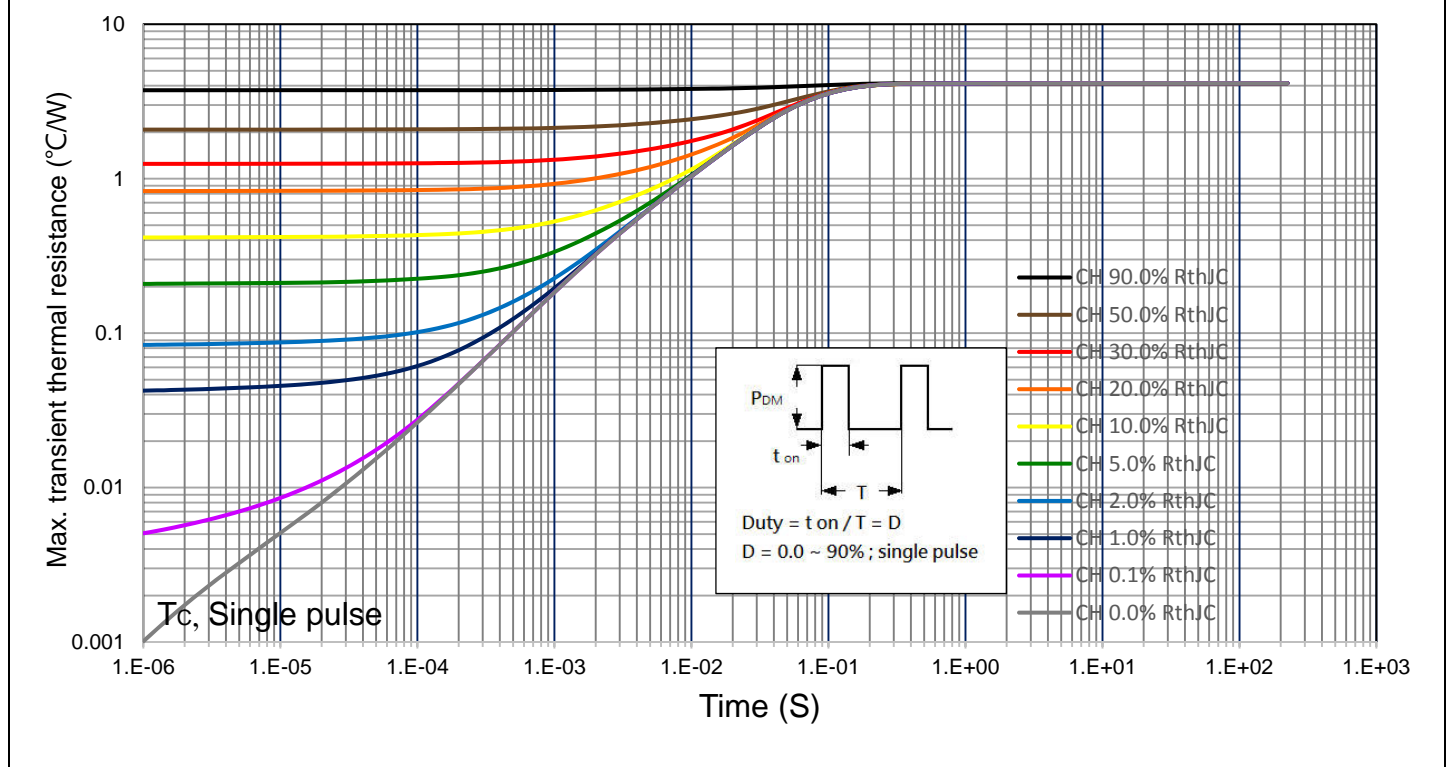

## Package of Dimension

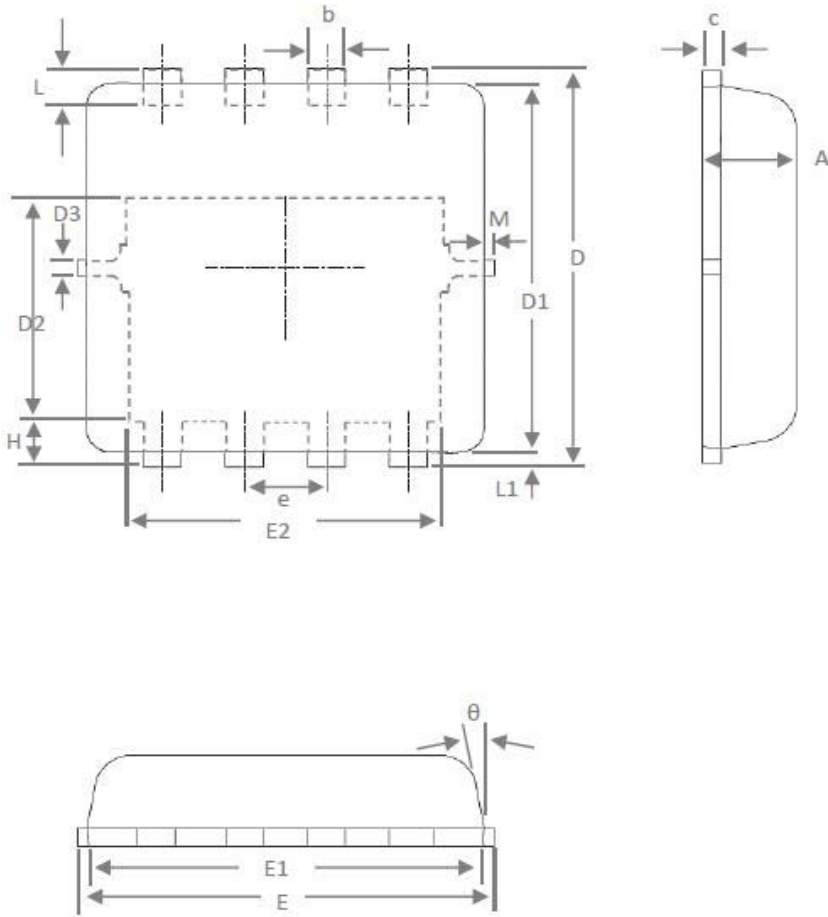

Symbol	Min	Nor	Max
A	0.70	0.75	0.80
b	0.25	0.30	0.35
c	0.10	0.15	0.25
D	3.25	3.35	3.45
D1	3.00	3.10	3.20
D2	1.78	1.88	1.98
D3	-	0.13	-
E	3.00	3.30	3.40
E1	3.00	3.15	3.20
E2	2.39	2.49	2.59
e	0.65BSC		
H	0.30	0.39	0.50
L	0.30	0.40	0.50
L1	-	0.13	-
θ	-	10°	12°
M	-	-	0.15

## Marking Information

PDFN 3.3x3.3-8L (E)	Marking Rule
<p data-bbox="124 365 293 398">Laser Marking</p> 	<p data-bbox="807 365 1070 398"><u>Line 1</u> : Device Name</p> <p data-bbox="807 409 903 443"><u>60N12E</u></p> <p data-bbox="807 499 1038 533"><u>Line 2</u> : Date Code</p> <p data-bbox="807 544 922 577">YMMXXX</p> <p data-bbox="807 633 983 667">Y : Year Code</p> <p data-bbox="807 678 1027 712">MM : Month Code</p> <p data-bbox="807 723 1062 757">XXX : Serial Number</p>

## Soldering Methods for Silicongear's Products

1. Storage environment: Temperature=10°C to 35°C Humidity=65%±15%
2. Reflow soldering of surface-mount devices

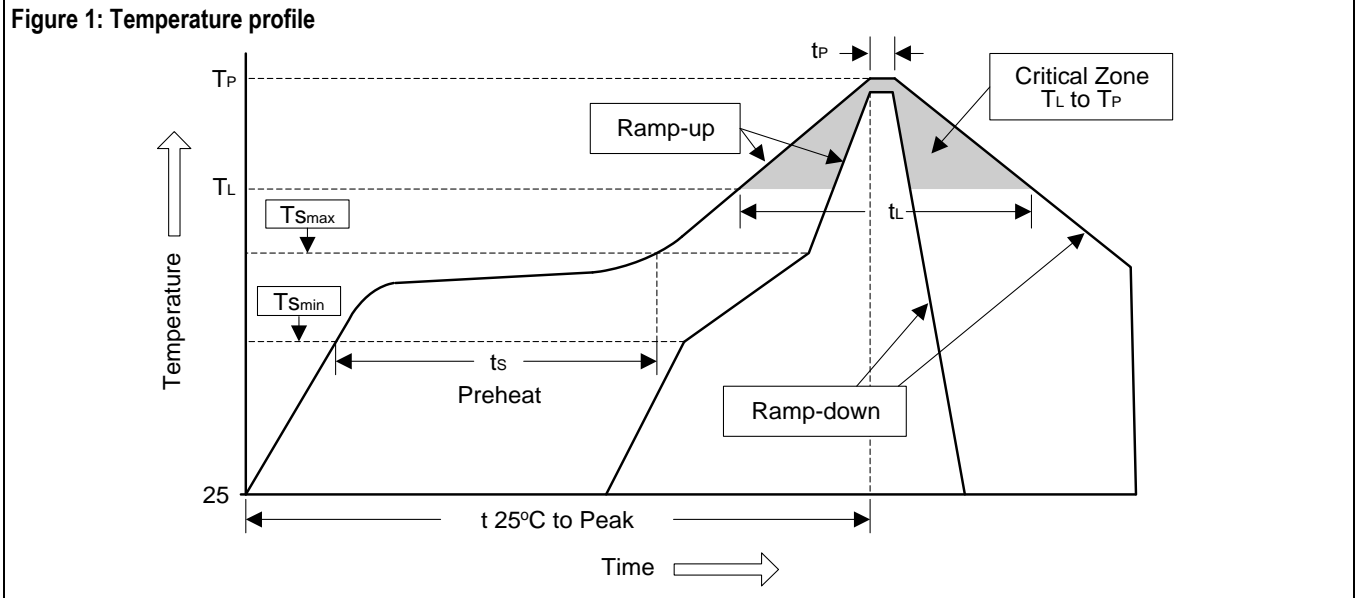

Profile Feature	Sn-Pb Eutectic Assembly	Pb-Free Assembly
Average ramp-up rate ( $T_L$ to $T_P$ )	<3°C/sec	<3°C/sec
Preheat		
- Temperature Min ( $T_{Smin}$ )	100°C	150°C
- Temperature Max ( $T_{Smax}$ )	150°C	200°C
- Time (min to max) ( $t_s$ )	60 to 120 sec	60 to 180 sec
$T_{Smax}$ to $T_L$		
- Ramp-up Rate	<3°C/sec	<3°C/sec
Time maintained above:		
- Temperature ( $T_L$ )	183°C	217°C
- Time ( $t_L$ )	60 to 150 sec	60 to 150 sec
Peak Temperature ( $T_P$ )	240°C +0/-5°C	260°C +0/-5°C
Time within 5°C of actual Peak Temperature ( $t_P$ )	10 to 30 sec	20 to 40 sec
Ramp-down Rate	<6°C/sec	<6°C/sec
Time 25°C to Peak Temperature	<6 minutes	<8 minutes

### 3. Flow (wave) soldering (solder dipping)

Products	Peak Temperature	Dipping Time
Pb devices.	245°C ±5°C	5sec ±1sec
Pb-Free devices.	260°C +0/-5°C	5sec ±1sec



## Important Notice

### © Silicongear Corporation

ALL PRODUCT, PRODUCT SPECIFICATIONS AND DATA ARE SUBJECT TO CHANGE WITHOUT NOTICE TO IMPROVE RELIABILITY, FUNCTION OR DESIGN OR OTHERWISE.

Silicongear cannot assume responsibility for use of any circuitry other than circuitry entirely embodied in an Silicongear product. No circuit patent licenses, copyrights, mask work rights, or other intellectual property rights are implied.

Silicongear Corporation, its affiliates, agents, and employees, and all persons acting on its or their behalf (collectively, "Silicongear"), disclaim any and all liability for any errors, inaccuracies or incompleteness contained in any datasheet or in any other disclosure relating to any product.

Silicongear makes no warranty, representation or guarantee regarding the suitability of the products for any particular purpose or the continuing production of any product. To the maximum extent permitted by applicable law, Silicongear disclaims (i) any and all liability arising out of the application or use of any product, (ii) any and all liability, including without limitation special, consequential or incidental damages, and (iii) any and all implied warranties, including warranties of fitness for particular purpose, non-infringement and merchantability.

Statements regarding the suitability of products for certain types of applications are based on Silicongear's knowledge of typical requirements that are often placed on Silicongear products in generic applications. Such statements are not binding statements about the suitability of products for a particular application. It is the customer's responsibility to validate that a particular product with the properties described in the product specification is suitable for use in a particular application. Parameters provided in datasheets and/or specifications may vary in different applications and performance may vary over time. All operating parameters, including typical parameters, must be validated for each customer application by the customer's technical experts. Product specifications do not expand or otherwise modify Silicongear's terms and conditions of purchase, including but not limited to the warranty expressed therein.

Except as expressly indicated in writing, Silicongear products are not designed for use in medical, life-saving, or life-sustaining applications or for any other application in which the failure of the Silicongear product could result in personal injury or death. Customers using or selling Silicongear products not expressly indicated for use in such applications do so at their own risk and agree to fully indemnify and hold Silicongear and its distributors harmless from and against any and all claims, liabilities, expenses and damages arising or resulting in connection with such use or sale, including attorneys fees, even if such claim alleges that Silicongear or its distributor was negligent regarding the design or manufacture of the part. Please contact authorized Silicongear personnel to obtain written terms and conditions regarding products designed for such applications.

No license, express or implied, by estoppel or otherwise, to any intellectual property rights is granted by this document or by any conduct of Silicongear. Product names and markings noted herein may be trademarks of their respective owners.

Silicongear and the Silicongear logo are trademarks of Silicongear Corporation. All other brand and product names appearing in this document are registered trademarks or trademarks of their respective holders.

## Revision History

Document Revision History			
Device	Date	Revision	Description (major change from last revision)
DG60N12E	Feb-15-2023	02	<ul style="list-style-type: none"><li>- Update symbol</li><li>- P<sub>D</sub> parameter revision</li><li>- Update typical operating characteristic diagrams Fig.11</li><li>- Added package dimensions section.</li><li>- Added revision history section.</li></ul>