

V_{DSS} , 60V R_{DS(ON)} , 4.5mΩ (max.) @ V_{GS}=10V R_{DS(ON)} , 5.5mΩ (max.) @ V_{GS}=4.5V I_D , 100A	TO-252	

Description	Features
<p>The SG60N03LD uses advanced Trench technology and designs to provide excellent R_{DS(ON)} with low gate charge. This device is suitable for use in PWM, load switching and general purpose applications.</p>	<ul style="list-style-type: none"> • Low On-Resistance • Low Input Capacitance • Low Miller Charge • Low Input / Output Leakage • Pb-free lead plating; RoHS compliant
	Applications
	<ul style="list-style-type: none"> • Lithium-Ion Secondary Batteries • Load Switch • DC-DC converters and Off-line UPS

Ordering Information

Ordering Code	RoHS Status	Package	Package Code	Packing	Quantity
SG60N03LD	Halogen-Free	TO-252	D	Tape & Reel	2,500

Absolute Maximum Ratings (T_A=25°C unless otherwise noted)

Parameter	Symbol	Value	Unit
Drain-Source Voltage	V _{DS}	60	V
Gate-Source Voltage	V _{GS}	±20	V
Drain Current-Continuous	I _D	T _C =25°C	100
		T _C =70°C	78
Drain Current-Pulsed <small>Note 1</small>	I _{DM}	450	A
Avalanche Current, L=0.5mH	I _{AS}	26	A
Avalanche Energy, L=0.5mH	E _{AS}	169	mJ
Maximum Power Dissipation	P _D	T _C =25°C	73
		T _C =70°C	47
Storage Temperature Range	T _{STG}	-55 to +150	°C
Operating Junction Temperature Range	T _J	-55 to +150	°C

Thermal Resistance Ratings

Parameter	Symbol	Conditions	Min.	Typ.	Max.	Unit
Maximum Junction-to-Ambient	R _{θJA}	Steady State	-	-	62	°C/W
Maximum Junction-to-Case	R _{θJC}	Steady State	-	-	1.7	°C/W

Electrical Characteristics (T_J=25°C unless otherwise noted)

OFF CHARACTERISTICS						
Parameter	Symbol	Conditions	Min.	Typ.	Max.	Unit
Drain-Source Breakdown Voltage	BV _{DSS}	V _{GS} =0V, I _{DS} =250μA	60	-	-	V
Zero Gate Voltage Drain Current	I _{DSS}	V _{DS} =48V, V _{GS} =0V	-	-	1	μA
Gate-Body Leakage	I _{GSS}	V _{GS} =±20V, V _{DS} =0V	-	-	±100	nA

ON CHARACTERISTICS						
Parameter	Symbol	Conditions	Min.	Typ.	Max.	Unit
Gate Threshold Voltage	V _{GS(TH)}	V _{DS} =V _{GS} , I _{DS} =250μA	1.5	1.8	2.3	V
Drain-Source On-State Resistance	R _{DS(ON)}	V _{GS} =10V, I _{DS} =20A	-	-	4.5	mΩ
Drain-Source On-State Resistance	R _{DS(ON)}	V _{GS} =4.5V, I _{DS} =10A	-	-	5.5	mΩ

DYNAMIC CHARACTERISTICS						
Parameter	Symbol	Conditions	Min.	Typ.	Max.	Unit
Input Capacitance	C _{iss}	V _{DS} =30V, V _{GS} =0V, f=1MHz	-	3686	-	pF
Output Capacitance	C _{oss}		-	357	-	
Reverse Transfer Capacitance	C _{rss}		-	124	-	

SWITCHING CHARACTERISTICS						
Parameter	Symbol	Conditions	Min.	Typ.	Max.	Unit
Turn-On Delay Time	T _{d(on)}	V _{DS} =30V, I _D =20A, V _{GS} =10V, R _{GEN} =3Ω	-	12	-	ns
Rise Time	t _r		-	4	-	
Turn-Off Delay Time	T _{d(off)}		-	50	-	
Fall Time	t _f		-	6	-	
Total Gate Charge at 10V	Q _g	V _{DS} =30V, I _{DS} =20A, V _{GS} =10V	-	50	-	nC
Gate to Source Gate Charge	Q _{gs}		-	15	-	
Gate to Drain "Miller" Charge	Q _{gd}		-	2.5	-	

DRAIN-SOURCE DIODE CHARACTERISTICS AND MAXIMUM RATINGS						
Parameter	Symbol	Conditions	Min.	Typ.	Max.	Unit
Drain-Source Diode Forward Voltage	V _{SD}	V _{GS} =0V, I _{DS} =1A	-	-	1.3	V
Body Diode Reverse Recovery Time	t _{rr}	I _F =20A, dI/dt=100A/μs	-	22	-	ns
Body Diode Reverse Recovery Charge	Q _{rr}		-	120	-	nC

- Notes:**
- Pulse Test: Pulse Width ≤ 300μs, Duty Cycle ≤ 2%.
 - R_{θJA} is the sum of the junction-to-case and case-to-ambient thermal resistance where the case thermal reference is defined as the solder mounting surface of the drain pins. R_{θJC} is guaranteed by design while R_{θJA} is determined by the user's board design. R_{θJA} shown below for single device operation on FR-4 in still air.

Typical Operating Characteristics

Output Characteristics

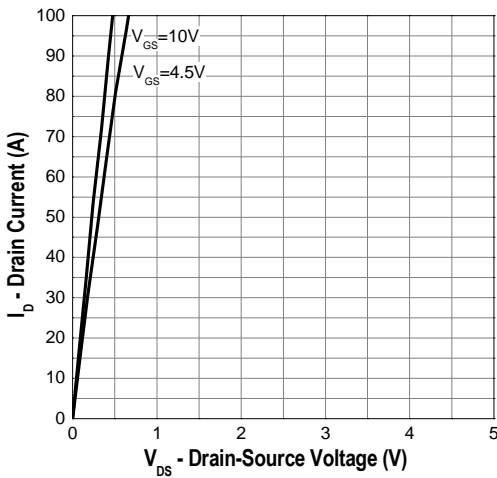

Gate Threshold Voltage

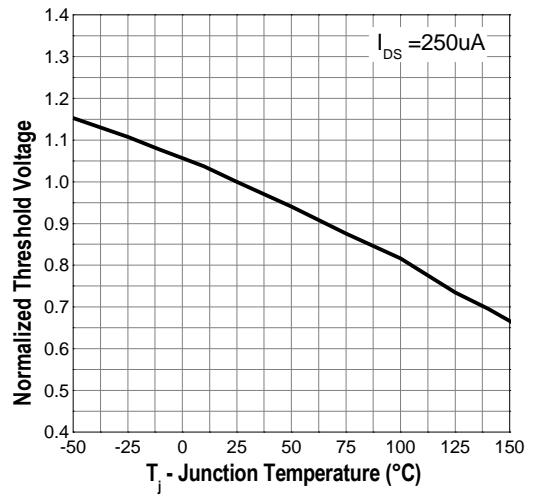

Gate-Source On Resistance

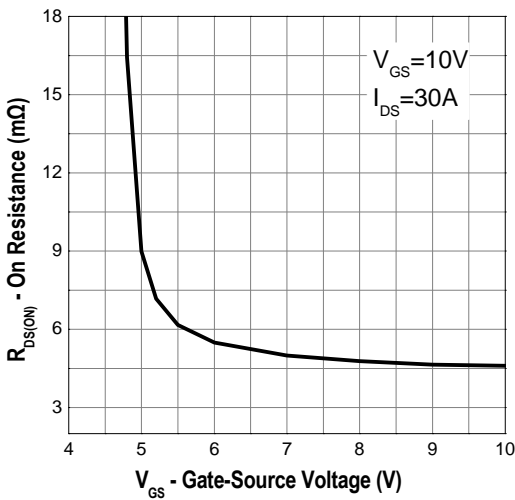

Drain-Source On Resistance

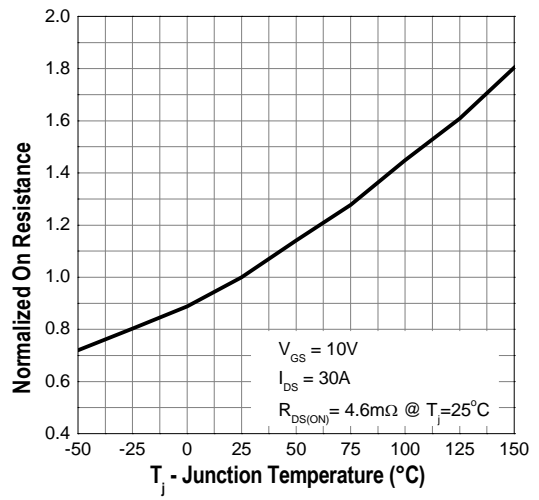

Drain-Source On Resistance

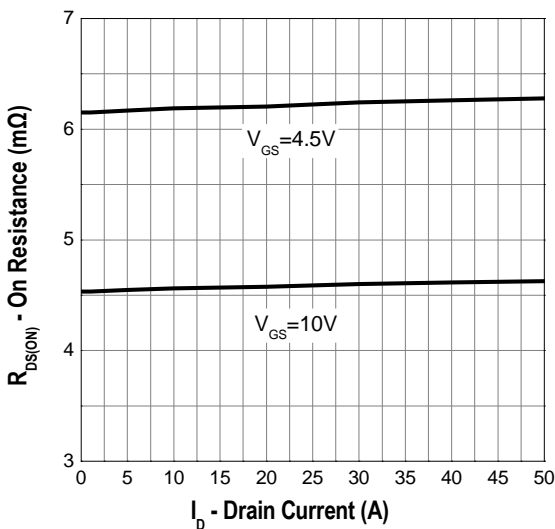

Source-Drain Diode Forward

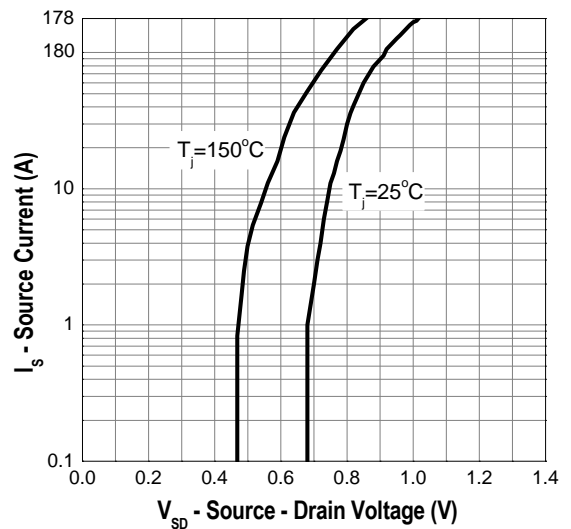

Typical Operating Characteristics (Cont.)

Power Dissipation

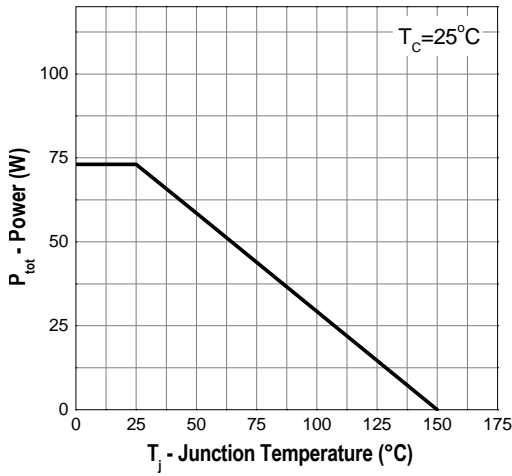

Drain Current

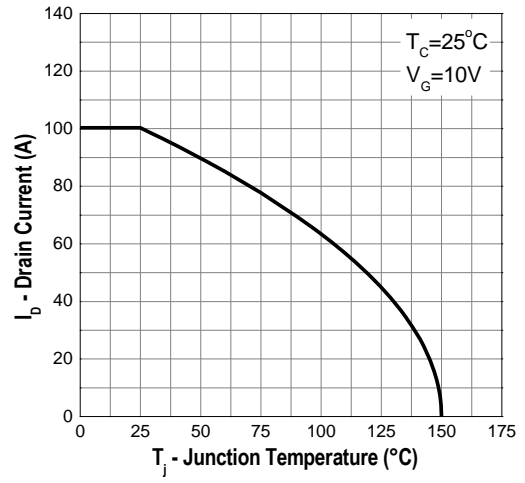

Safe Operation Area

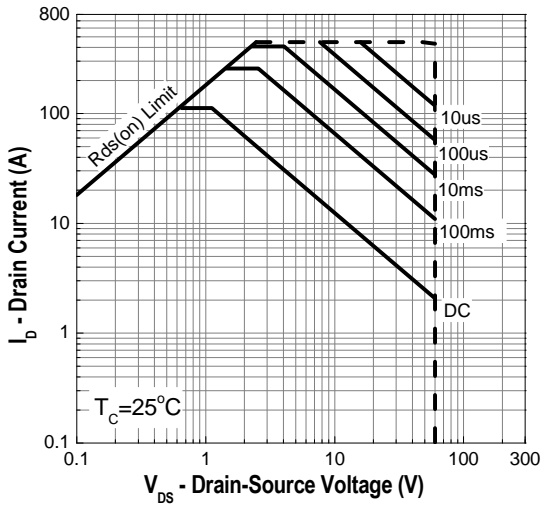

Transient Thermal Impedance

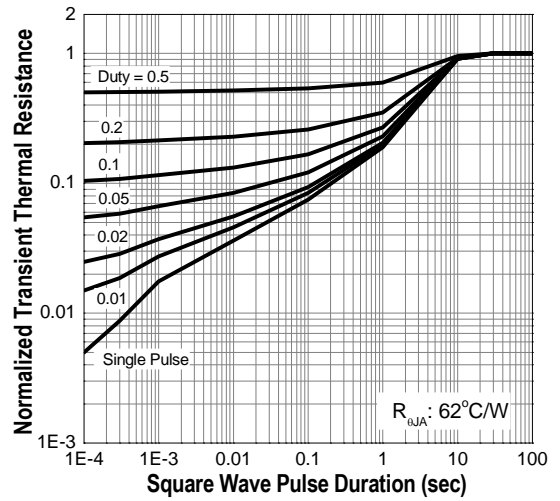

Capacitance

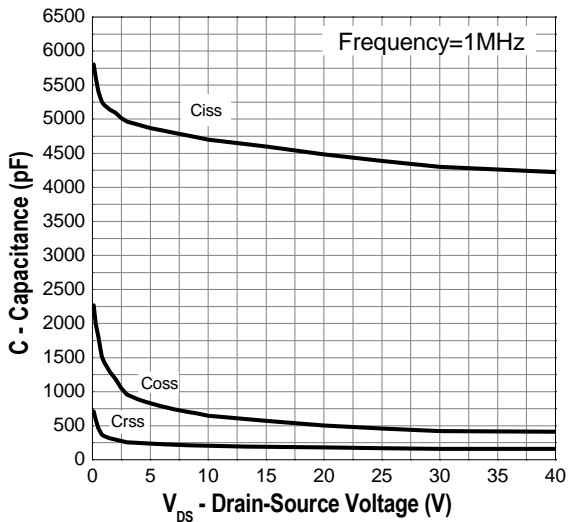

Gate Charge

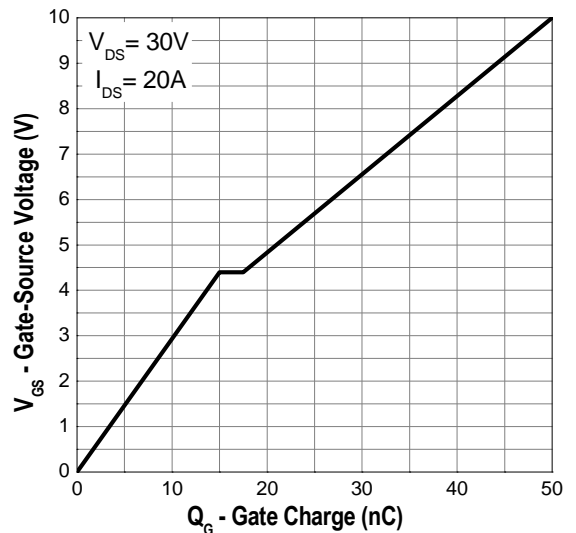

Marking Information

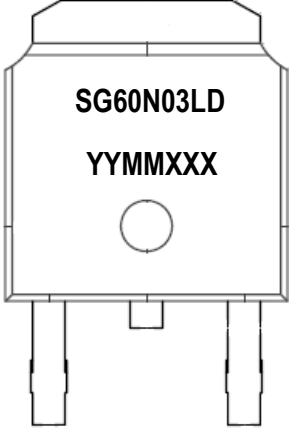
TO-252 (D)	Marking Rule
<p>Laser Marking</p>  <p>Diagram</p>	<p><u>Line 1</u> : Device Name SG60N03LD</p> <p><u>Line 2</u> : Date Code YYMMXXX</p> <p>YY : Year Code MM : Month Code XXX : Serial Number</p>

Package of Dimension

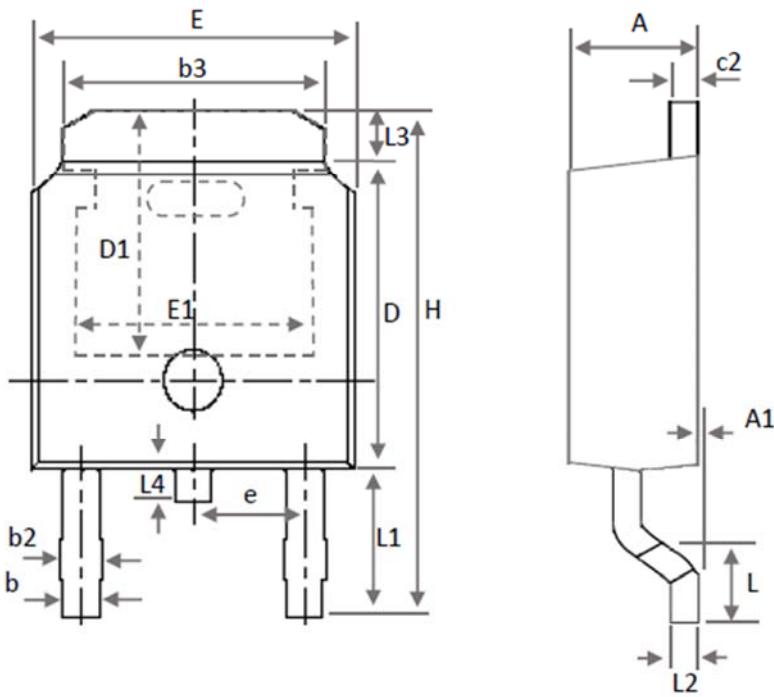

Symbol	Min	Nor	Max
E	6.35	6.54	6.731
L	1.40	1.59	1.78
L1	2.743 Ref.		
L2	0.508 BSC		
L3	0.89	1.08	1.27
L4	0.60	0.81	1.01
D	5.97	6.10	6.223
H	9.40	9.91	10.41
b	0.64	0.77	0.89
b2	0.76	0.95	1.14
b3	4.95	5.21	5.46
e	2.286 BSC		
A	2.18	2.29	2.39
A1	0.00	0.07	0.13
c2	0.46	0.68	0.89
D1	5.21	-	-
E1	4.32	-	-

Soldering Methods for Silicongear's Products

1. Storage environment: Temperature=10°C to 35°C Humidity=65%±15%
2. Reflow soldering of surface-mount devices

Figure 1: Temperature profile

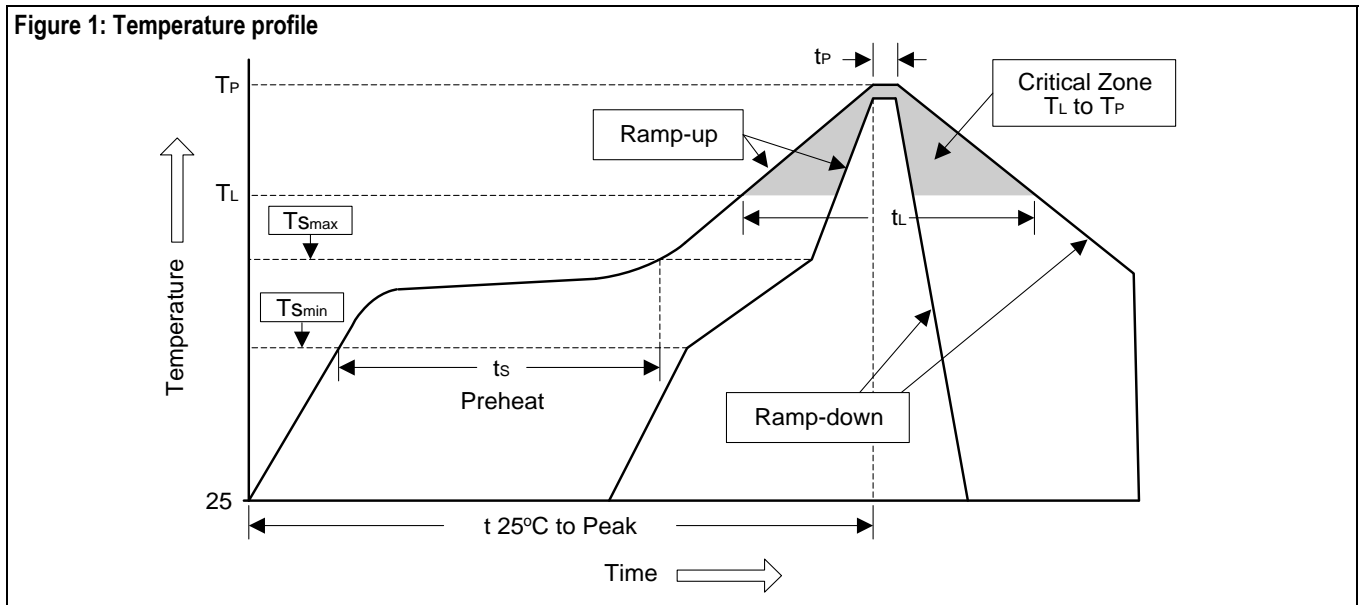

Profile Feature	Sn-Pb Eutectic Assembly	Pb-Free Assembly
Average ramp-up rate (T_L to T_P)	<3°C/sec	<3°C/sec
Preheat		
- Temperature Min (T_{Smin})	100°C	150°C
- Temperature Max (T_{Smax})	150°C	200°C
- Time (min to max) (t_s)	60 to 120 sec	60 to 180 sec
T_{Smax} to T_L		
- Ramp-up Rate	<3°C/sec	<3°C/sec
Time maintained above:		
- Temperature (T_L)	183°C	217°C
- Time (t_L)	60 to 150 sec	60 to 150 sec
Peak Temperature (T_P)	240°C +0/-5°C	260°C +0/-5°C
Time within 5°C of actual Peak Temperature (t_P)	10 to 30 sec	20 to 40 sec
Ramp-down Rate	<6°C/sec	<6°C/sec
Time 25°C to Peak Temperature	<6 minutes	<8 minutes

3. Flow (wave) soldering (solder dipping)

Products	Peak Temperature	Dipping Time
Pb devices.	245°C ±5°C	5sec ±1sec
Pb-Free devices.	260°C +0/-5°C	5sec ±1sec

Important Notice

© Silicongear Corporation

ALL PRODUCT, PRODUCT SPECIFICATIONS AND DATA ARE SUBJECT TO CHANGE WITHOUT NOTICE TO IMPROVE RELIABILITY, FUNCTION OR DESIGN OR OTHERWISE.

Silicongear cannot assume responsibility for use of any circuitry other than circuitry entirely embodied in an Silicongear product. No circuit patent licenses, copyrights, mask work rights, or other intellectual property rights are implied.

Silicongear Corporation, its affiliates, agents, and employees, and all persons acting on its or their behalf (collectively, "Silicongear"), disclaim any and all liability for any errors, inaccuracies or incompleteness contained in any datasheet or in any other disclosure relating to any product.

Silicongear makes no warranty, representation or guarantee regarding the suitability of the products for any particular purpose or the continuing production of any product. To the maximum extent permitted by applicable law, Silicongear disclaims (i) any and all liability arising out of the application or use of any product, (ii) any and all liability, including without limitation special, consequential or incidental damages, and (iii) any and all implied warranties, including warranties of fitness for particular purpose, non-infringement and merchantability.

Statements regarding the suitability of products for certain types of applications are based on Silicongear's knowledge of typical requirements that are often placed on Silicongear products in generic applications. Such statements are not binding statements about the suitability of products for a particular application. It is the customer's responsibility to validate that a particular product with the properties described in the product specification is suitable for use in a particular application. Parameters provided in datasheets and/or specifications may vary in different applications and performance may vary over time. All operating parameters, including typical parameters, must be validated for each customer application by the customer's technical experts. Product specifications do not expand or otherwise modify Silicongear's terms and conditions of purchase, including but not limited to the warranty expressed therein.

Except as expressly indicated in writing, Silicongear products are not designed for use in medical, life-saving, or life-sustaining applications or for any other application in which the failure of the Silicongear product could result in personal injury or death. Customers using or selling Silicongear products not expressly indicated for use in such applications do so at their own risk and agree to fully indemnify and hold Silicongear and its distributors harmless from and against any and all claims, liabilities, expenses and damages arising or resulting in connection with such use or sale, including attorneys fees, even if such claim alleges that Silicongear or its distributor was negligent regarding the design or manufacture of the part. Please contact authorized Silicongear personnel to obtain written terms and conditions regarding products designed for such applications.

No license, express or implied, by estoppel or otherwise, to any intellectual property rights is granted by this document or by any conduct of Silicongear. Product names and markings noted herein may be trademarks of their respective owners.

Silicongear and the Silicongear logo are trademarks of Silicongear Corporation. All other brand and product names appearing in this document are registered trademarks or trademarks of their respective holders.